

WHAT YOU NEED

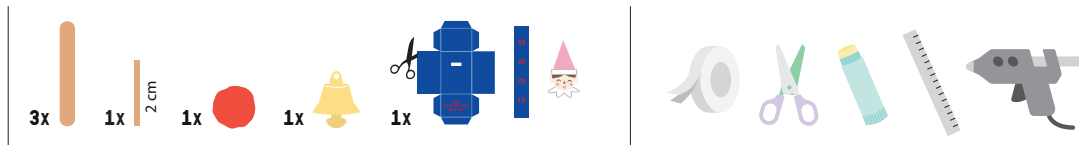

1

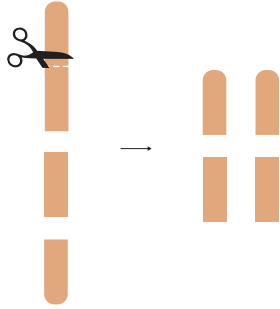

2

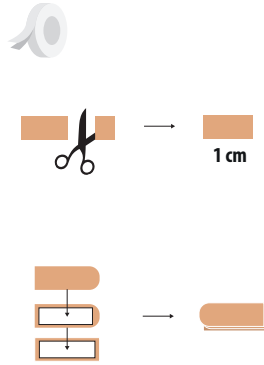

3

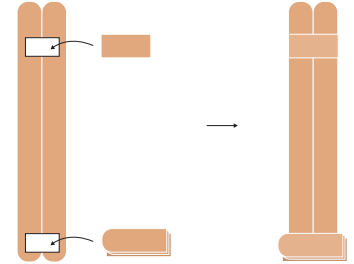

4

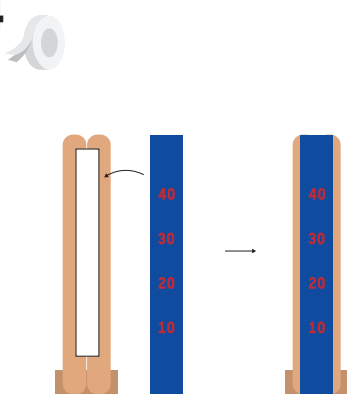

5



6

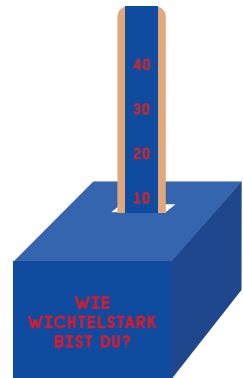

7

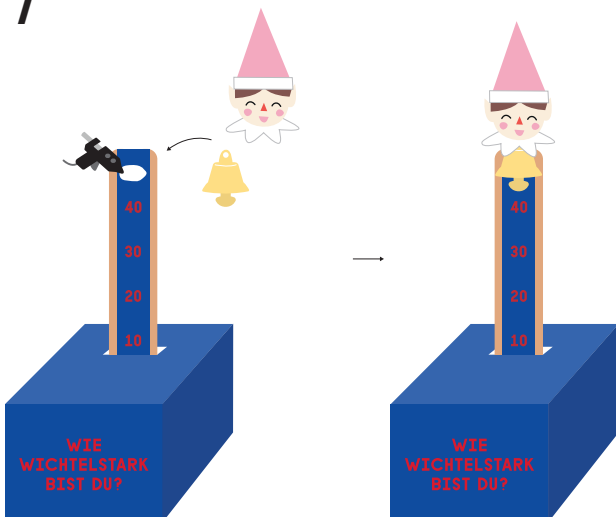

8

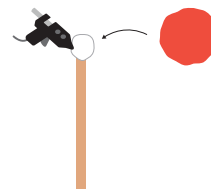

9

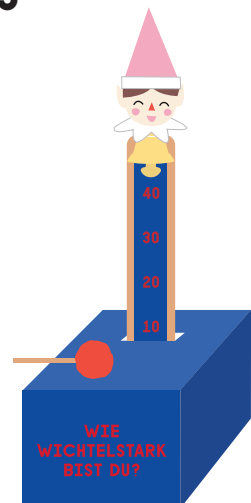

WHAT YOU NEED

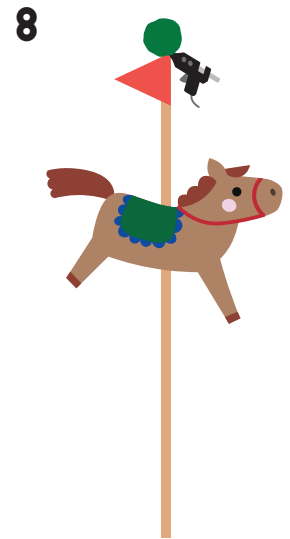
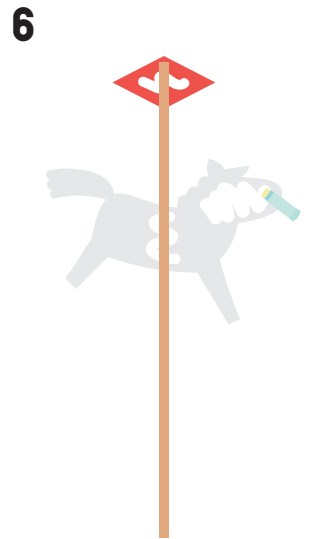
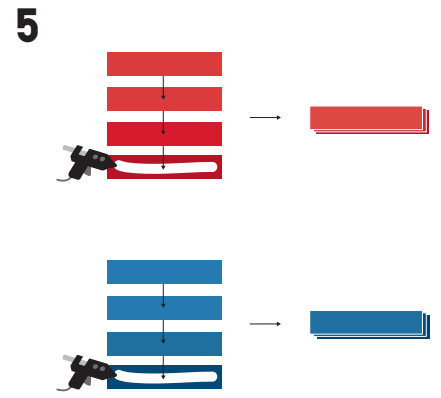
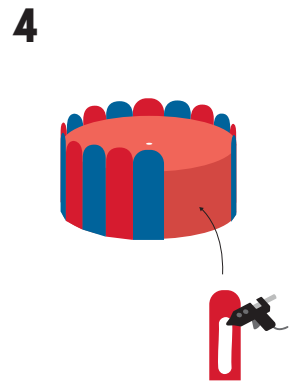
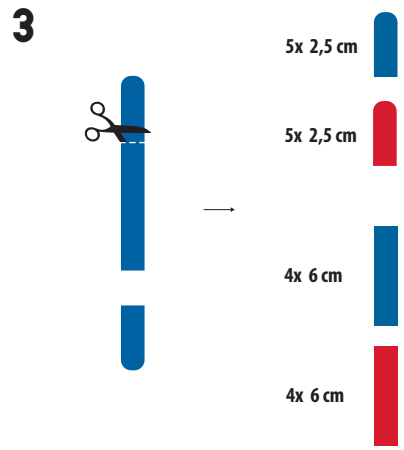
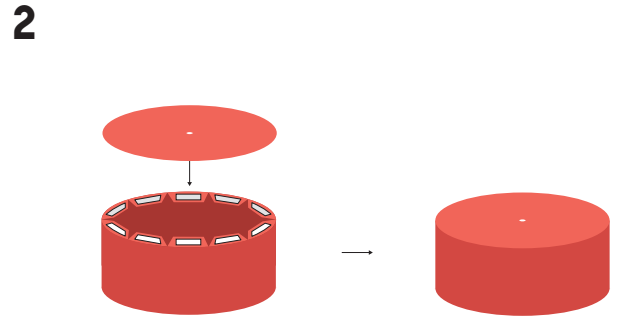
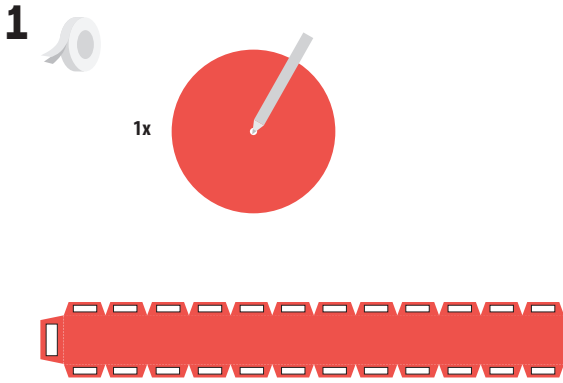
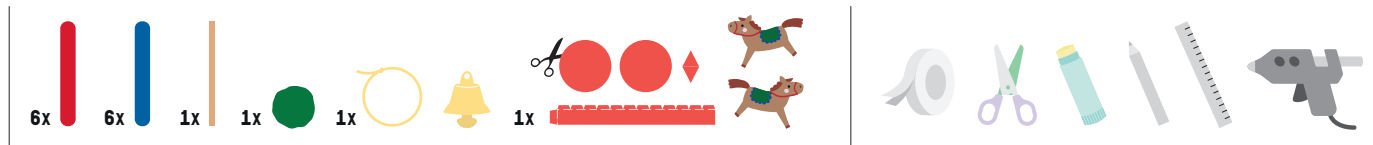

9



10



11



12



13



14



15

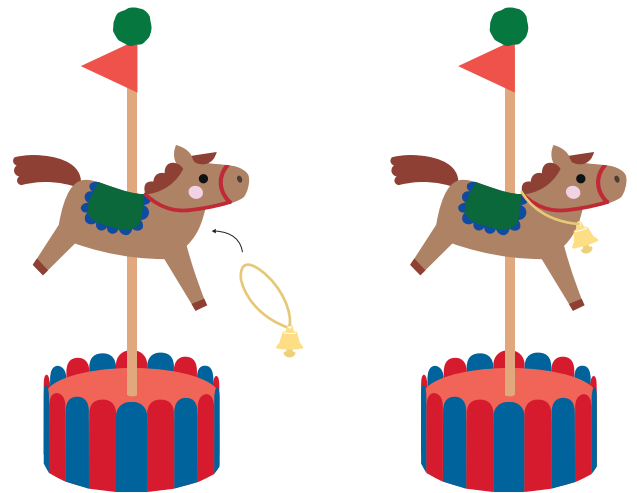

WHAT YOU NEED

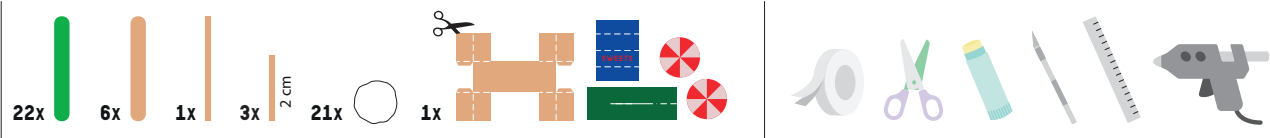

1



2

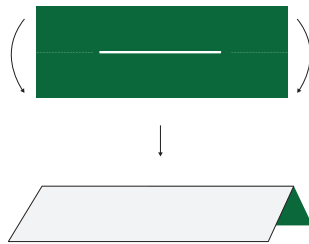

3

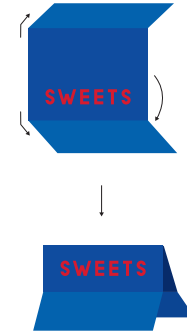

4



5

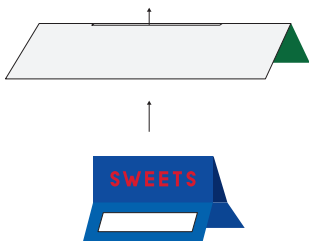

6



7

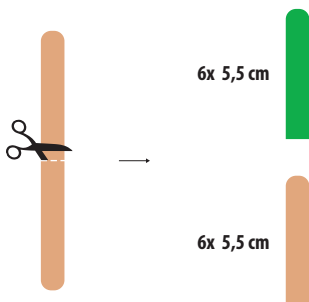

8

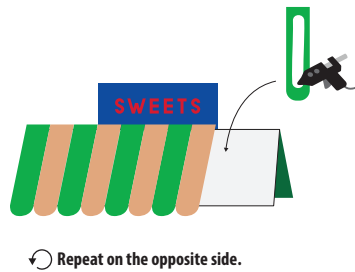

↻ Repeat on the opposite side.

9



10

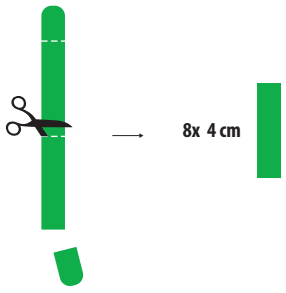

11

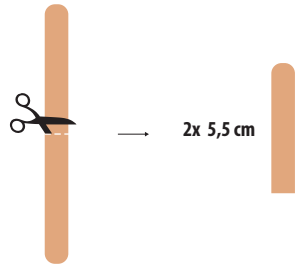

12

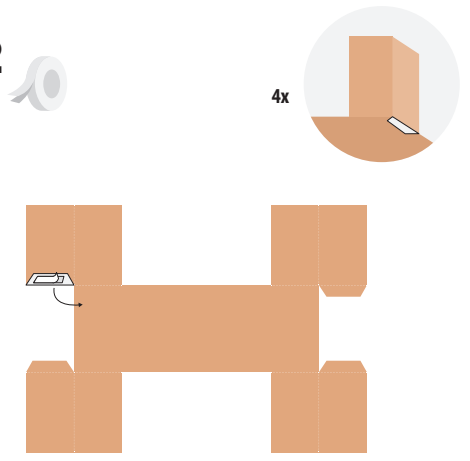

13



14

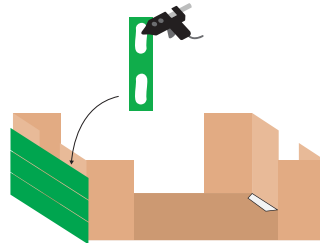

Repeat on the opposite side.

15



16

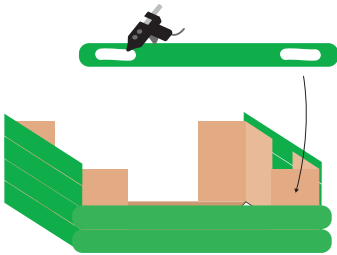

Repeat on the opposite side.

17

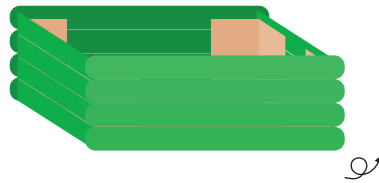

18

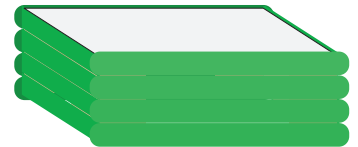

19

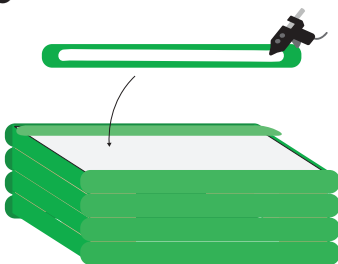

20



21

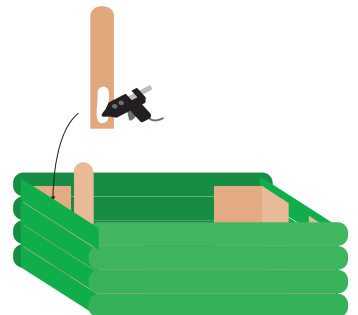

22

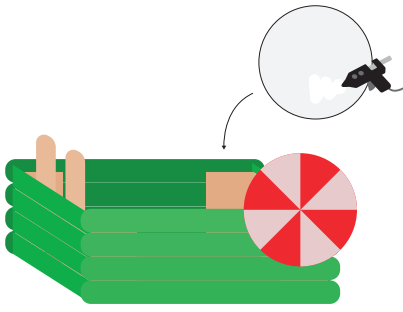

23

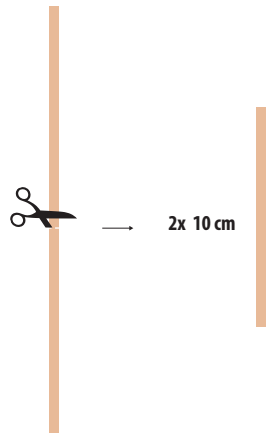

24

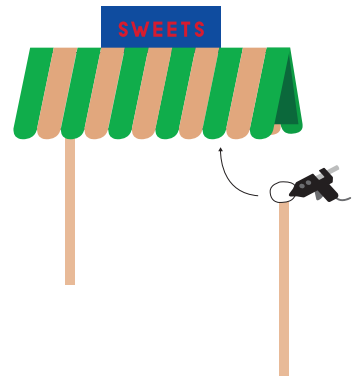

25

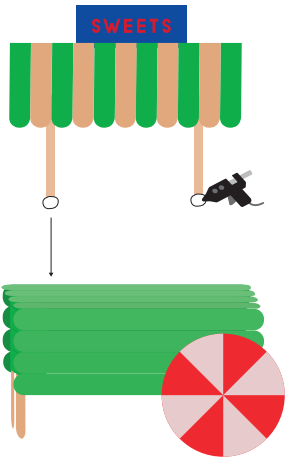

26

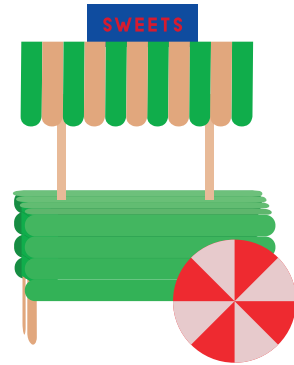

27

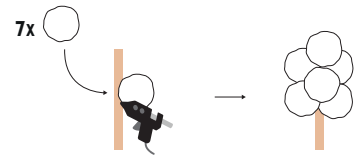

28

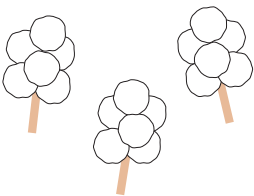

29

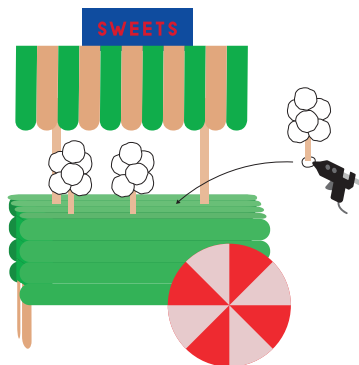

30

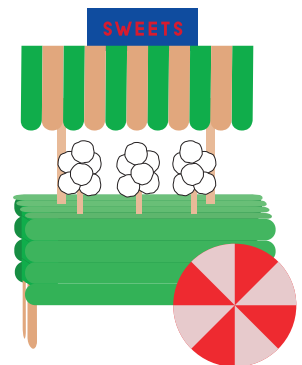

WHAT YOU NEED

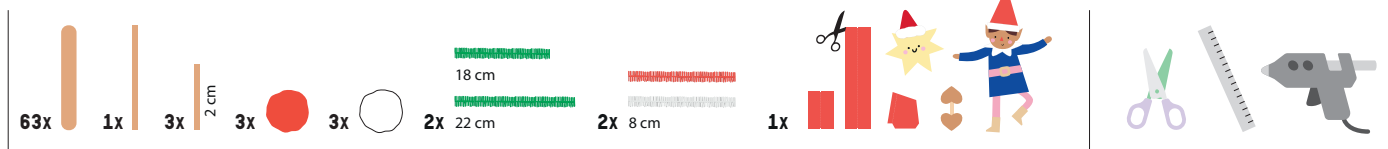

1

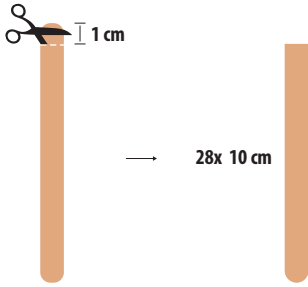

2

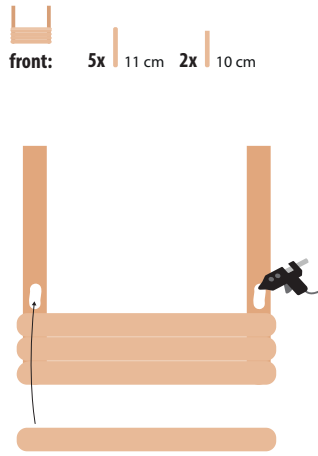

3

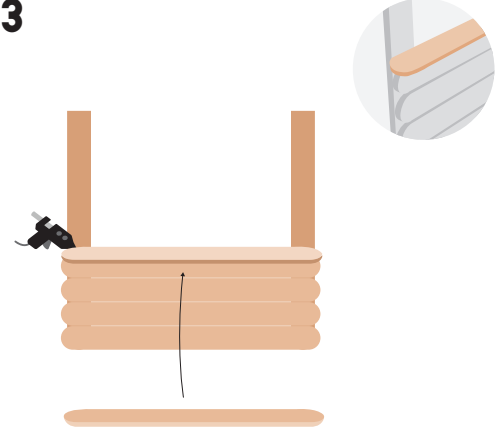

4



5

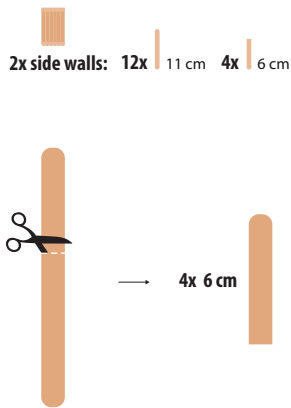

6

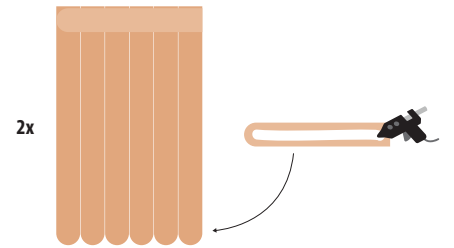

7

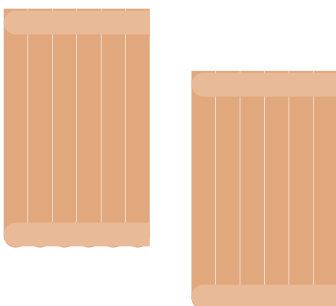

8

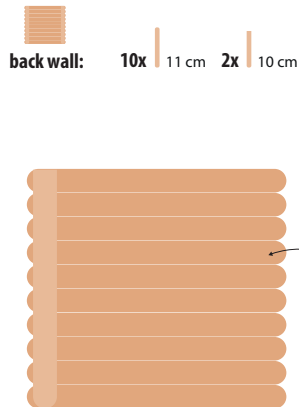

9

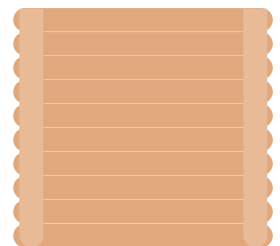

10

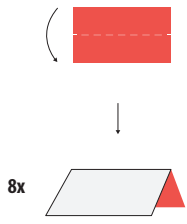

11

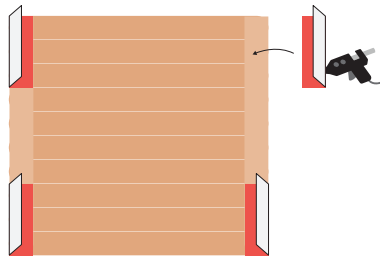

12

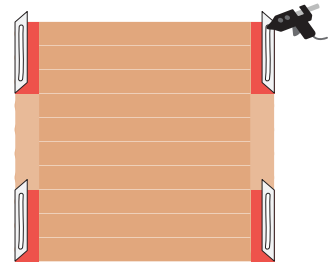

13

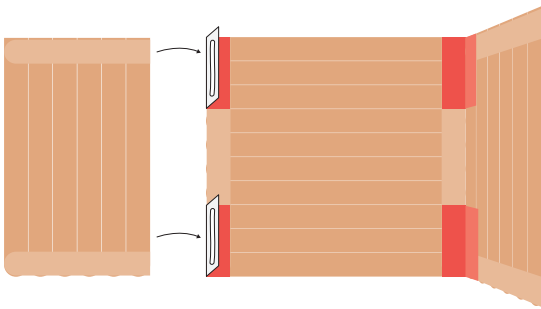

14

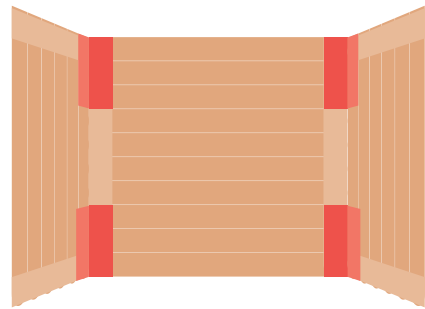

15

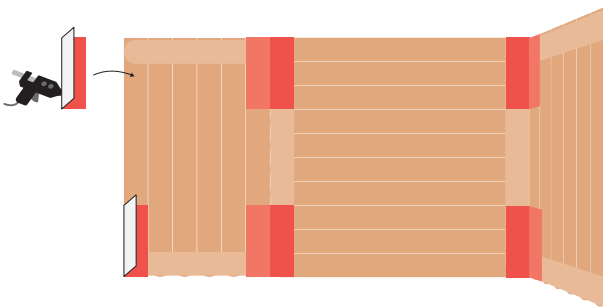

16

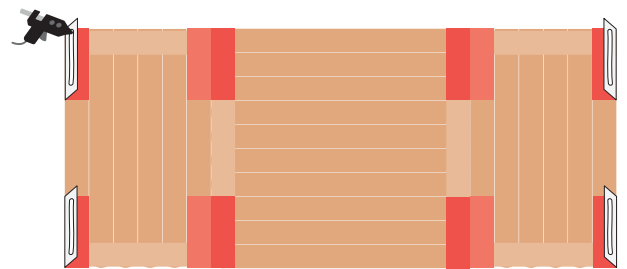

17

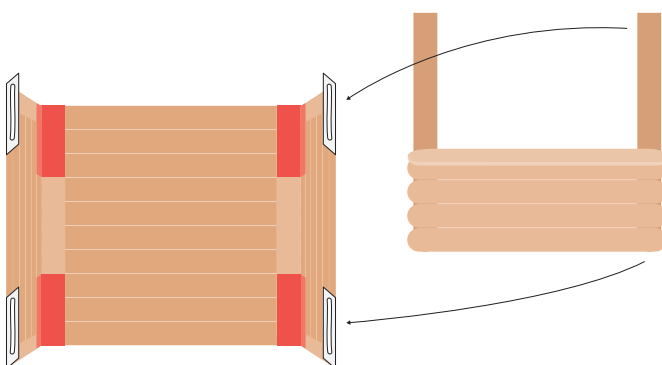

18

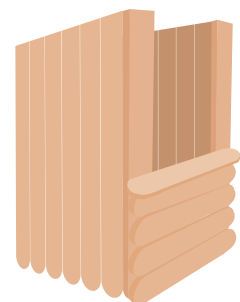

19 2x gable for roof: 10x 11 cm 4x 5,5 cm

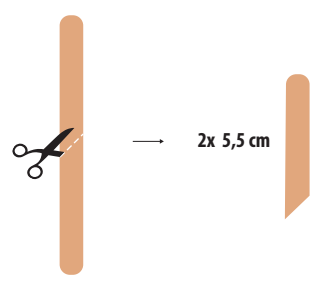

Cut diagonally in half.

20 2x

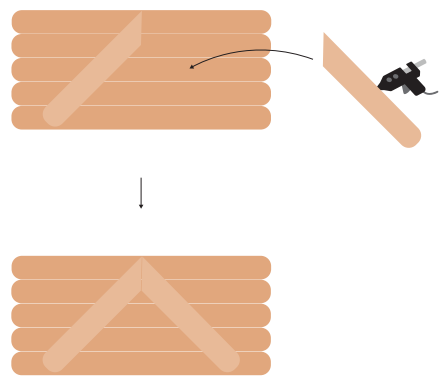

21 2x

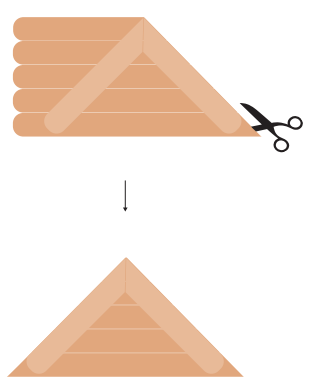

22

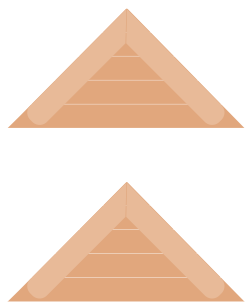

23 2x roof parts: 12x 10 cm 4x 8 cm

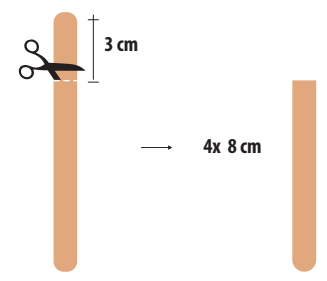

24

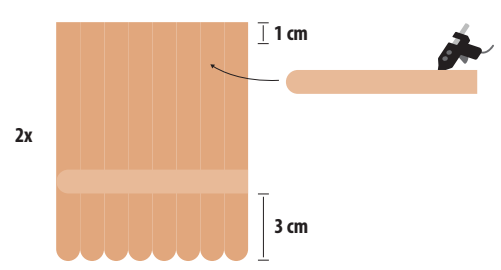

25

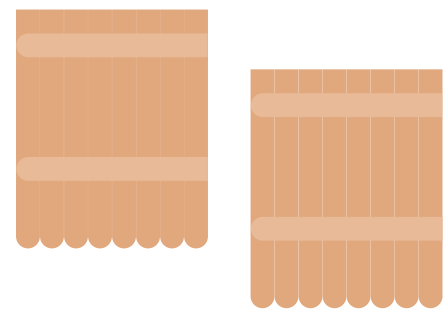

26 roof

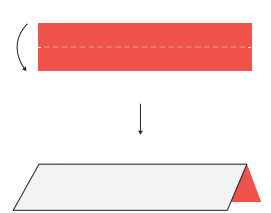

27

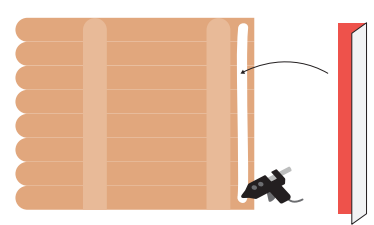

28

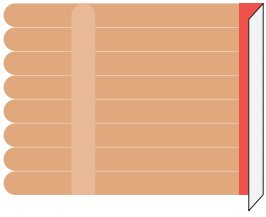

29

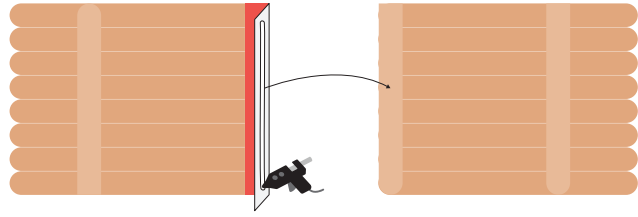

30

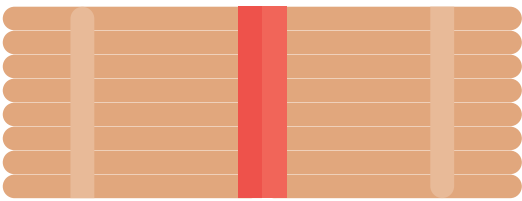

31

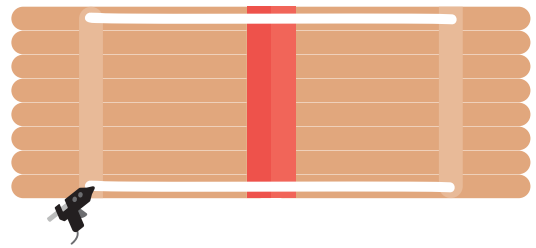

32

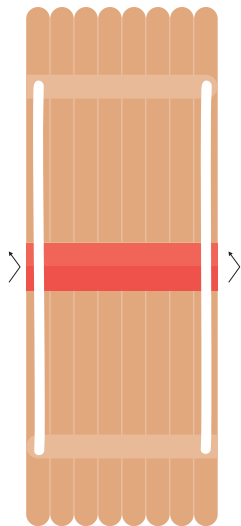

33

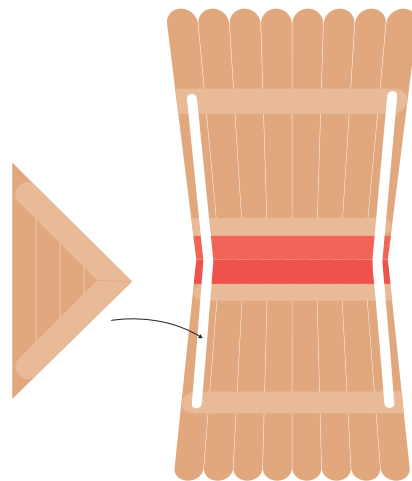

34

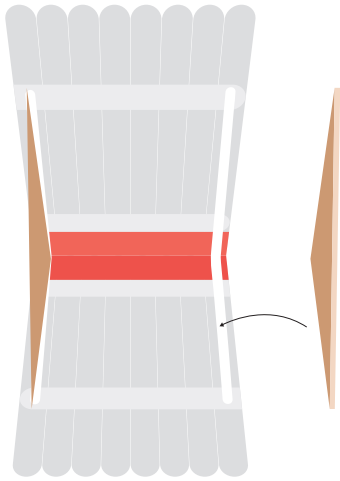

35

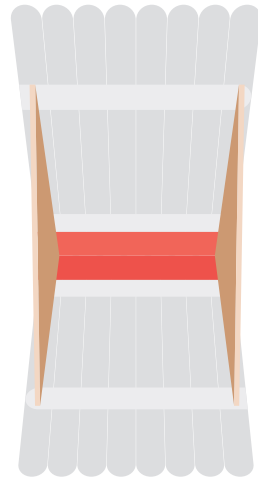

36

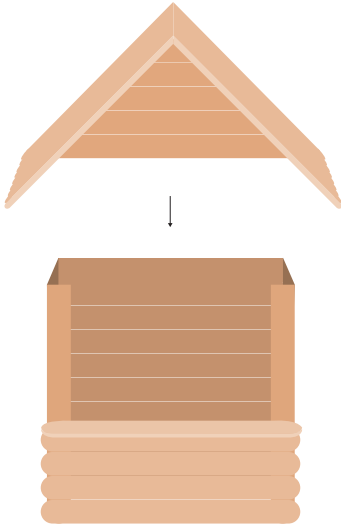

37

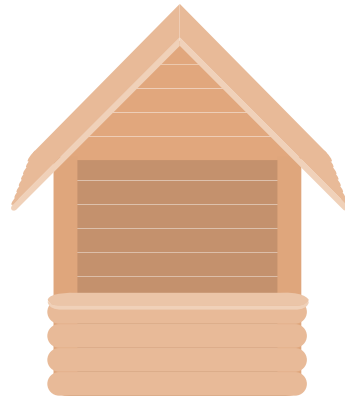

38

18 cm

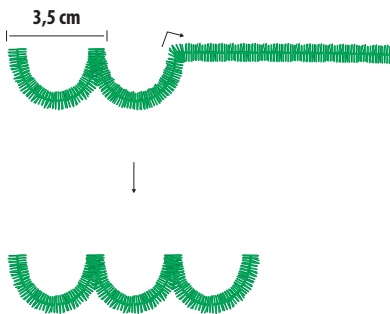

39

22 cm

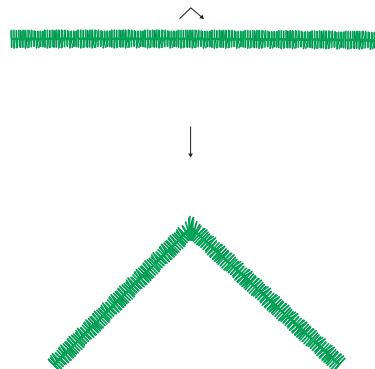

40 2x 8 cm



41



42



1x 10 cm



43

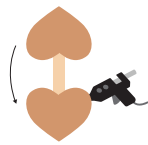

44



45

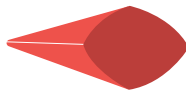
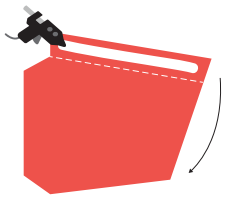

46

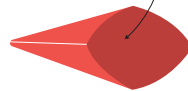

47 3x 2 cm

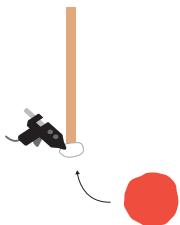

48

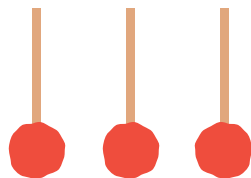

49



50

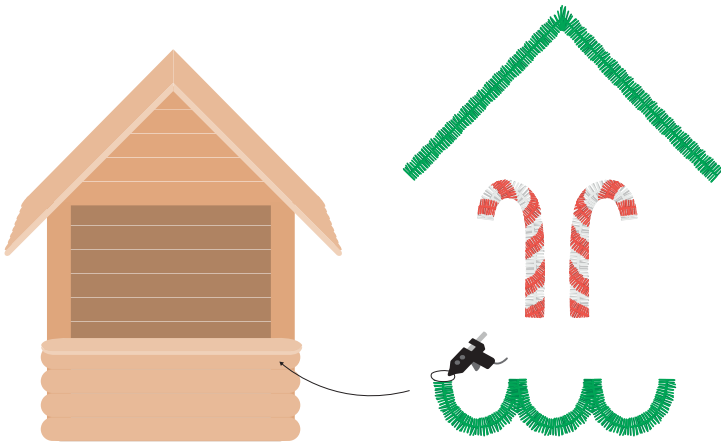

51

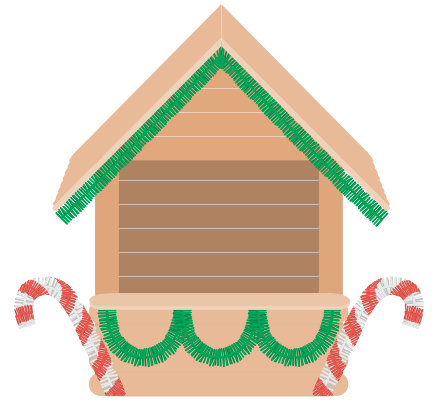

52

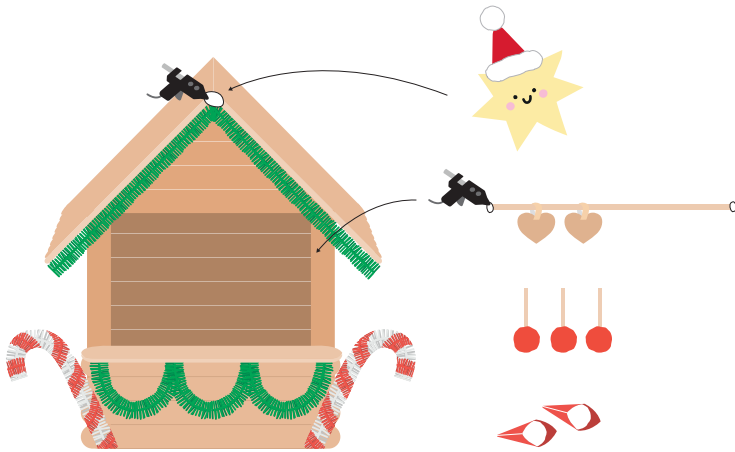

53



54



55



WHAT YOU NEED



1

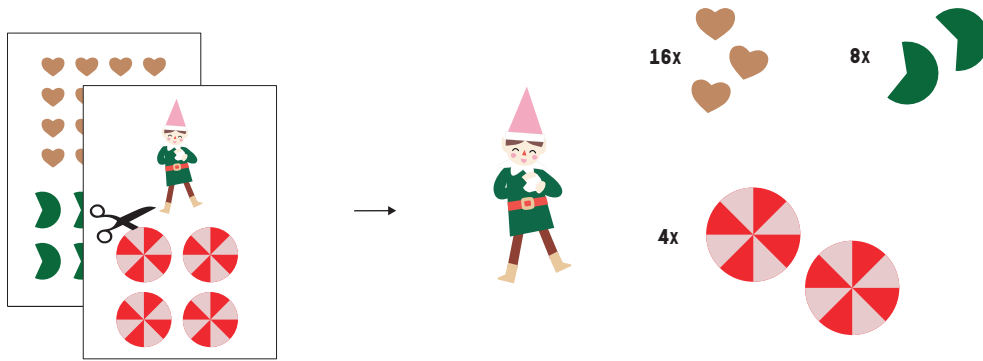

2 2x

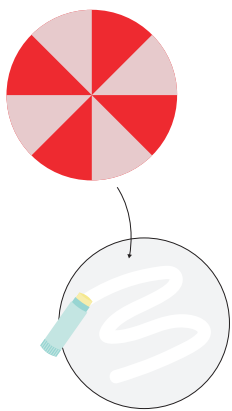

Glue two discs together.

3 2x

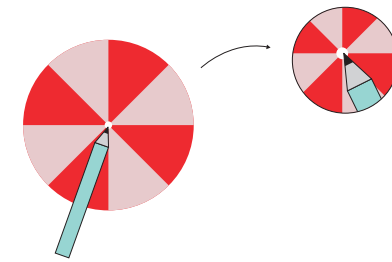

Pierce a hole in the middle.

4

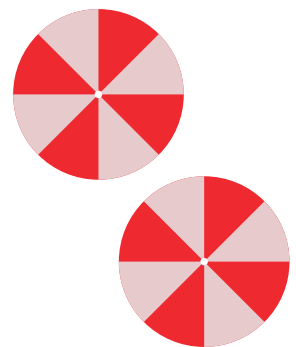

5

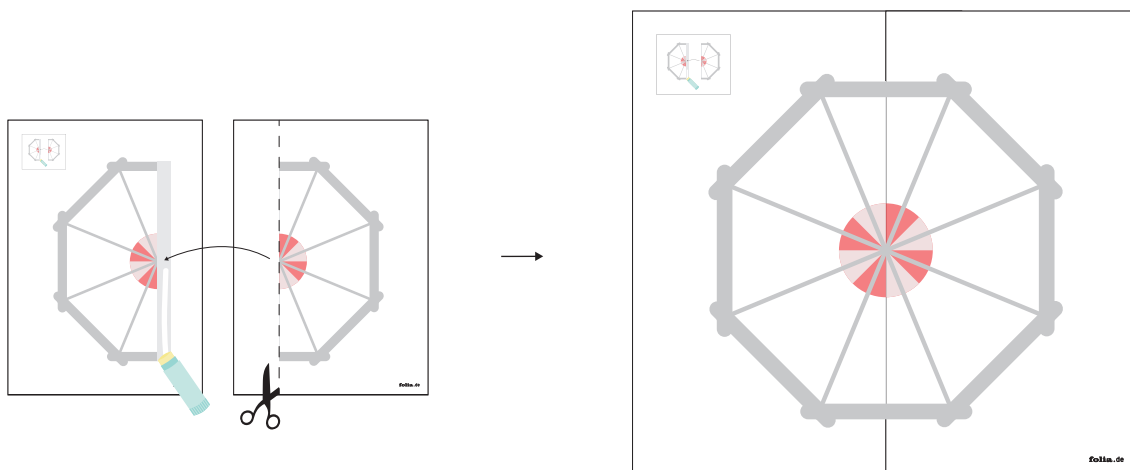

6

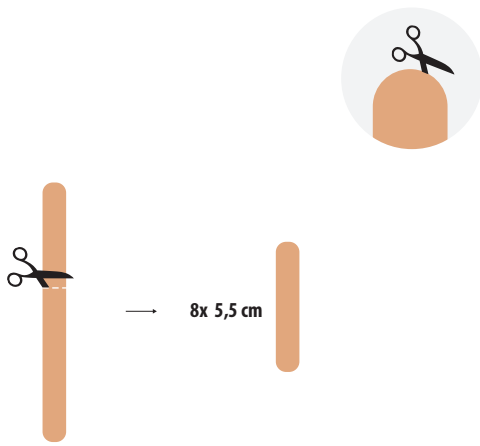

7 8x

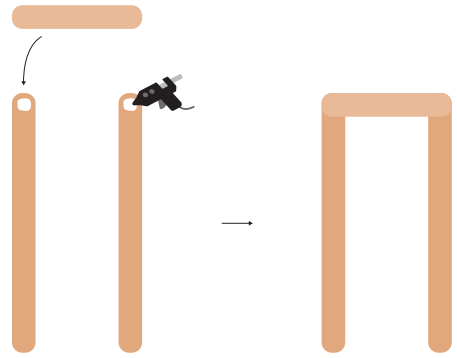

8

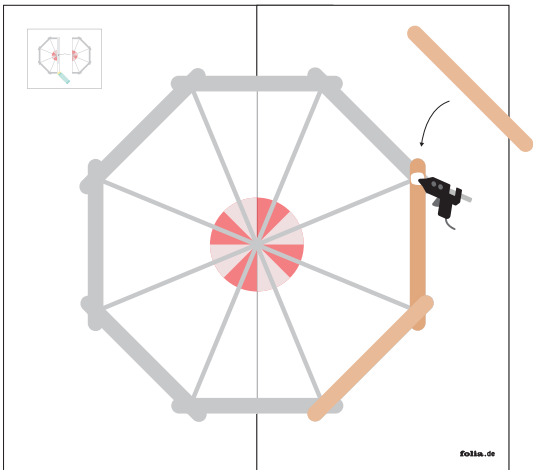

Use the template to position the popsicle sticks.

9

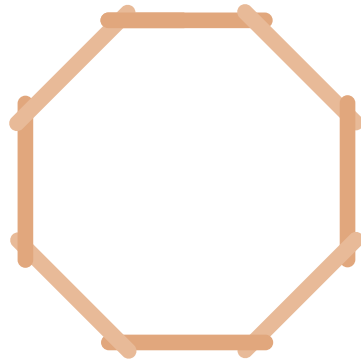

10 ↻ Repeat (8-9)

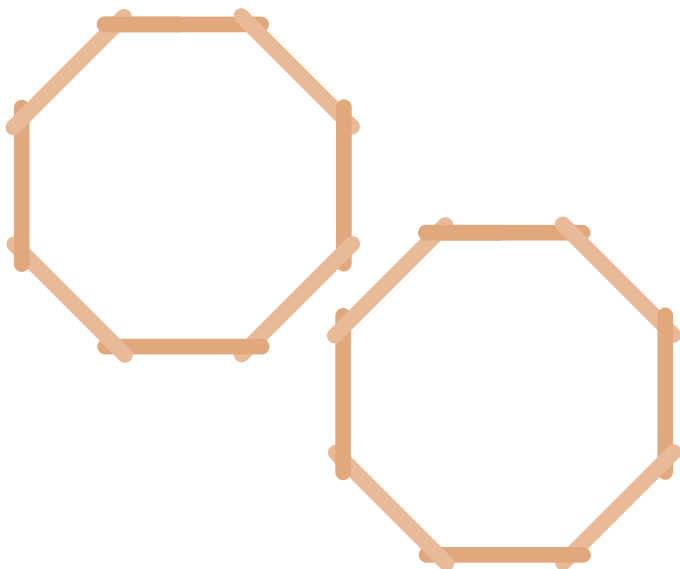

11

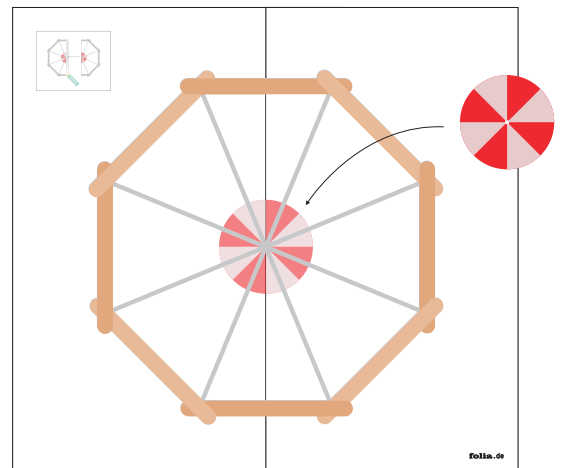

12 8x

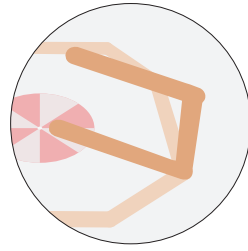
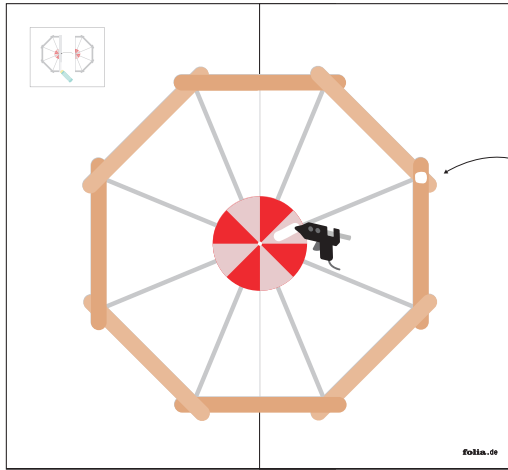

13

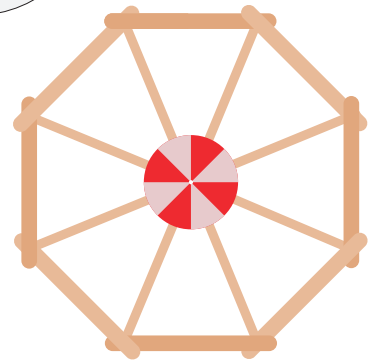
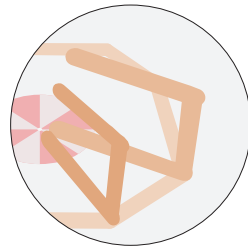
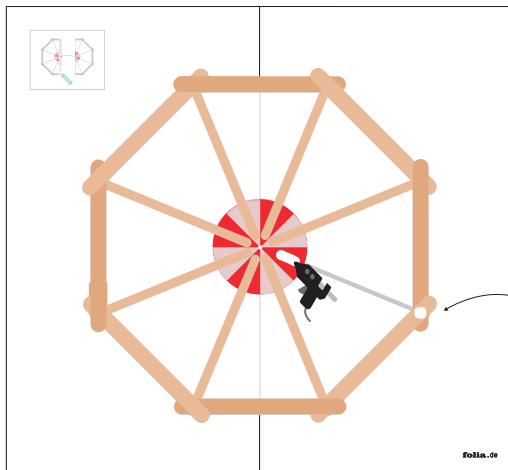

14

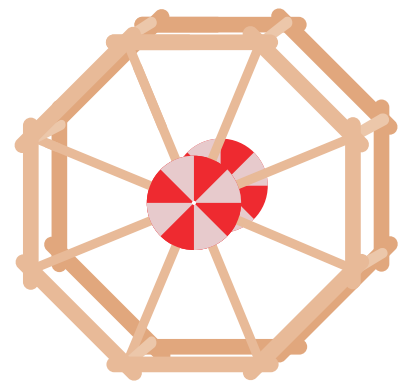
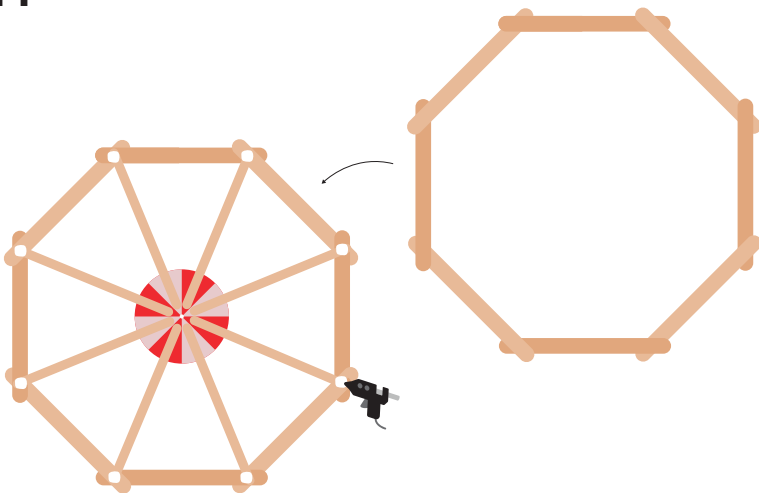

15

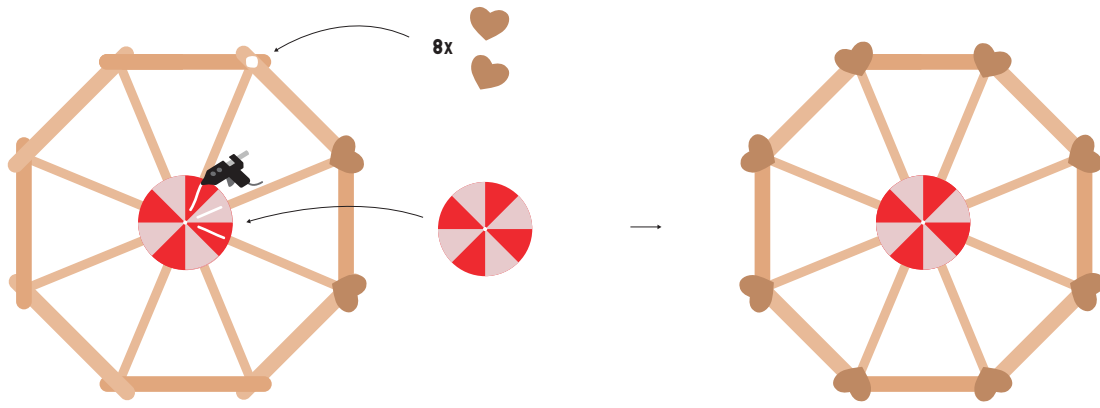

↻ Repeat on the opposite side.

16 2x

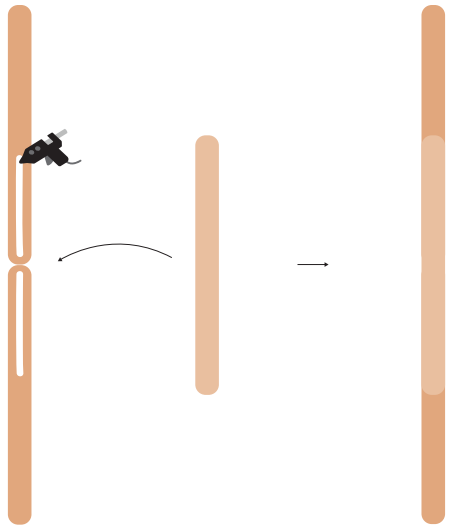

17

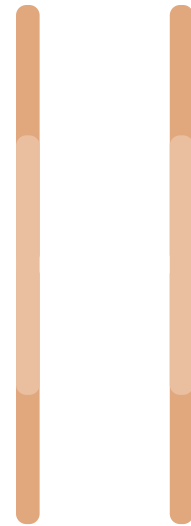

↻ Turn over.

18

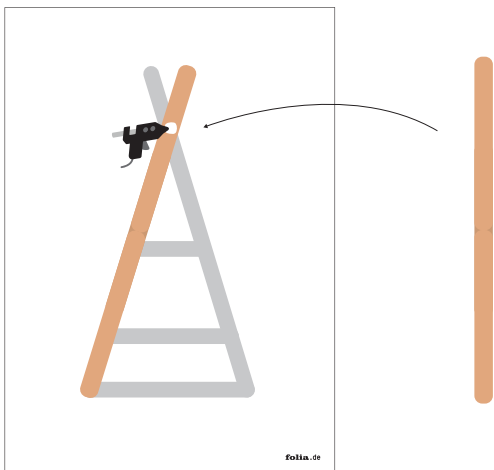

Use the template to position the popsicle sticks.

19

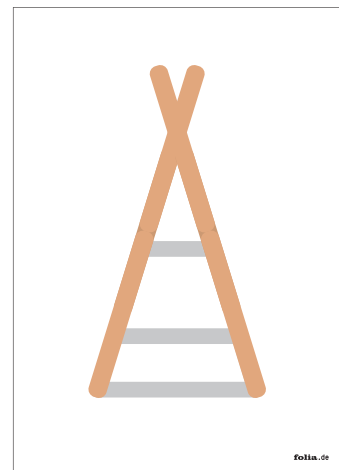

20

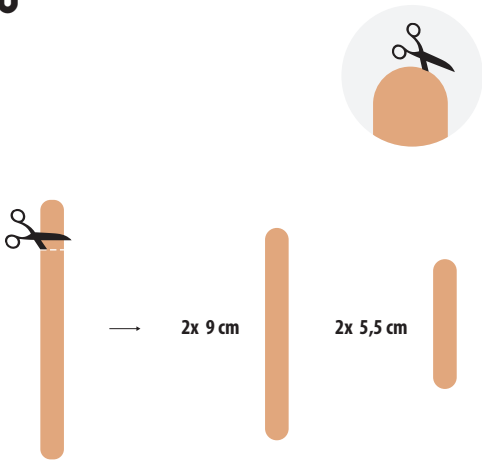

21

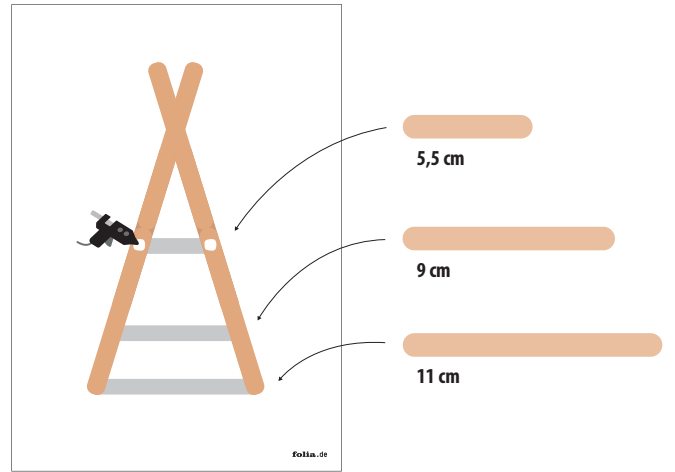

22

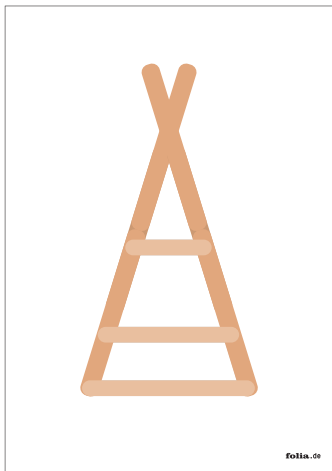

23 Repeat (21 - 22)

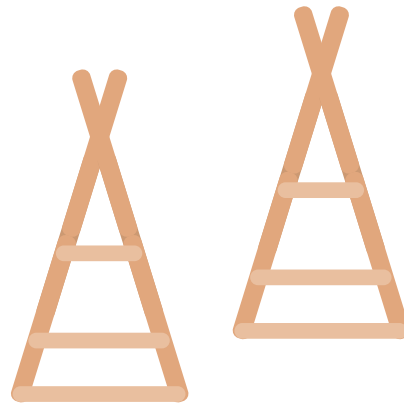

24

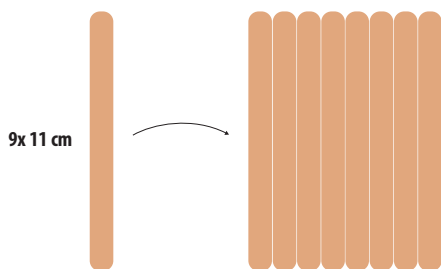

25

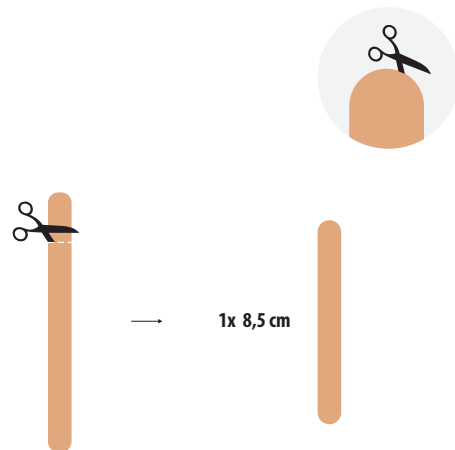

26

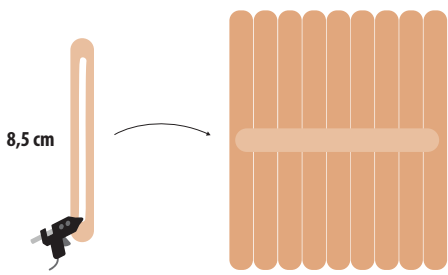

27

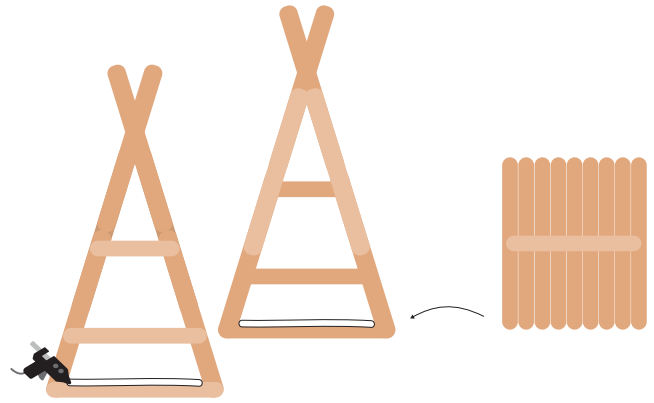

28

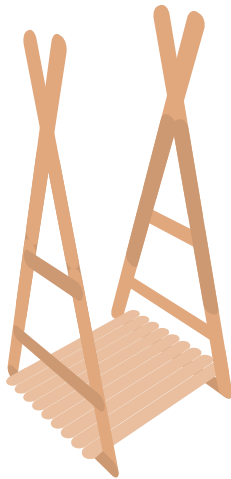

29

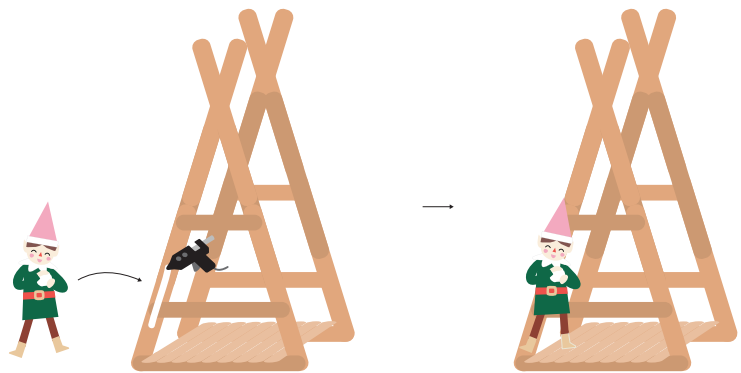

30



31

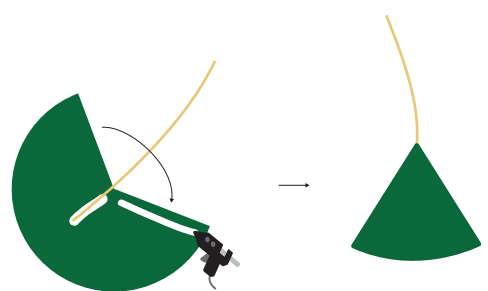
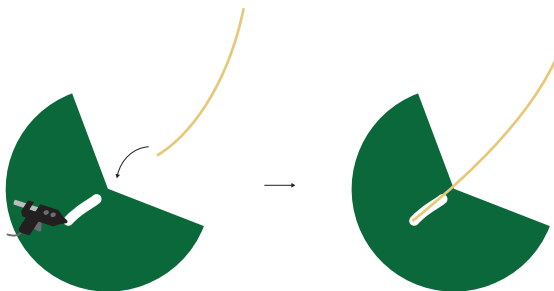

32

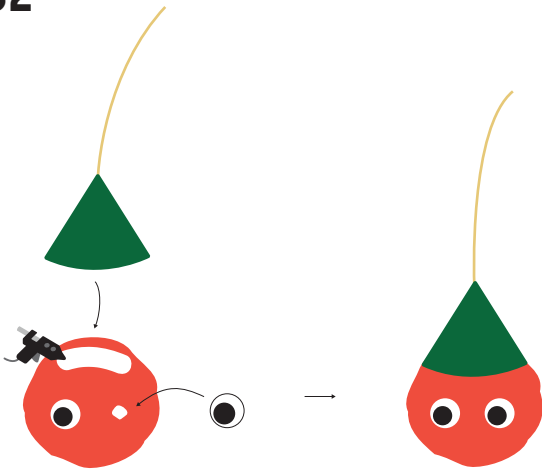

33 Repeat 8x (29 - 31)

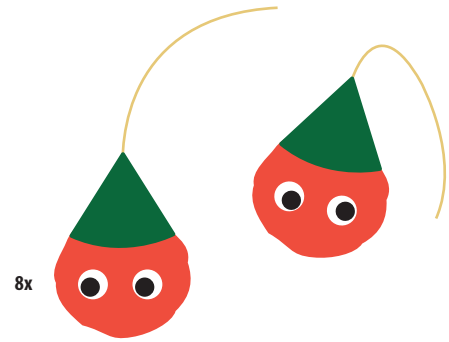

34 8x

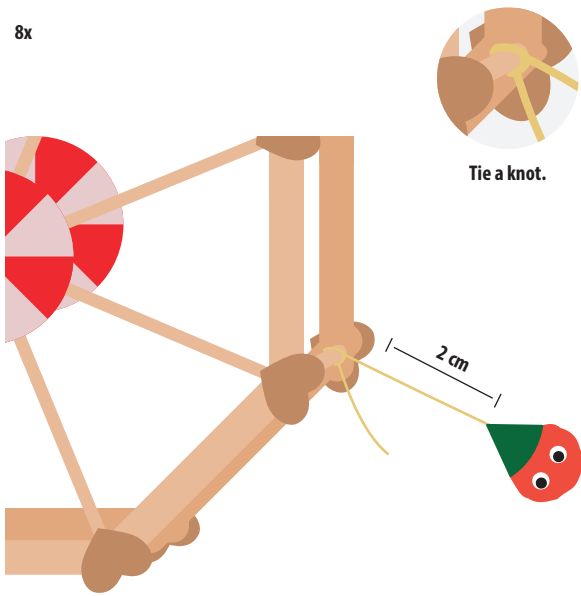

35 8x

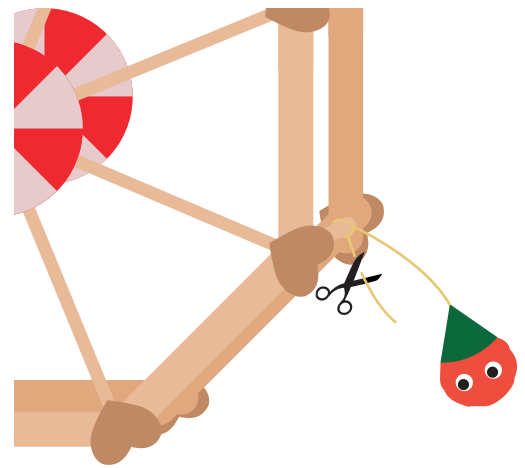

36

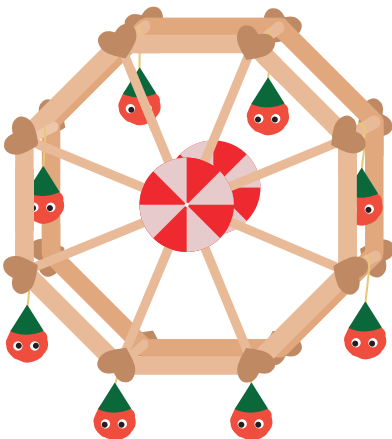

37

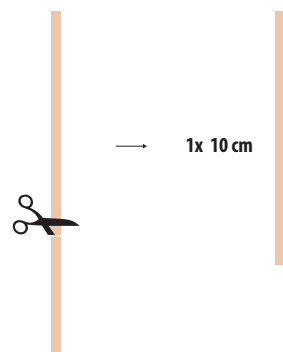

38

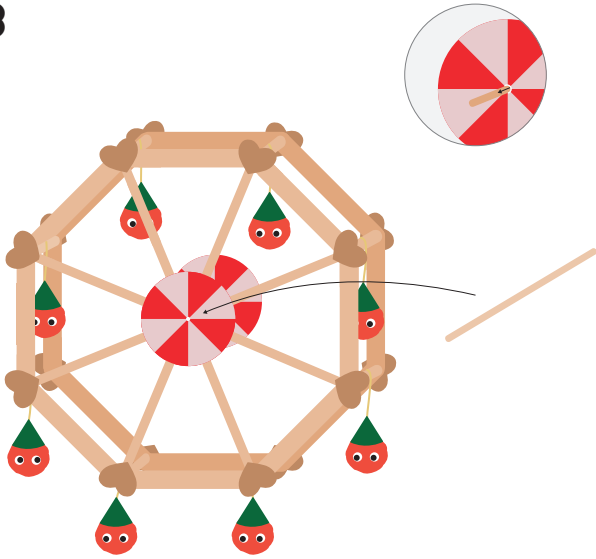

39

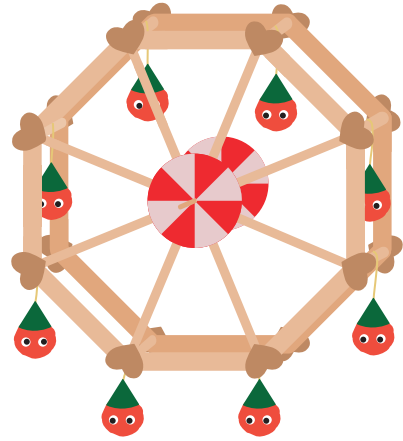

40

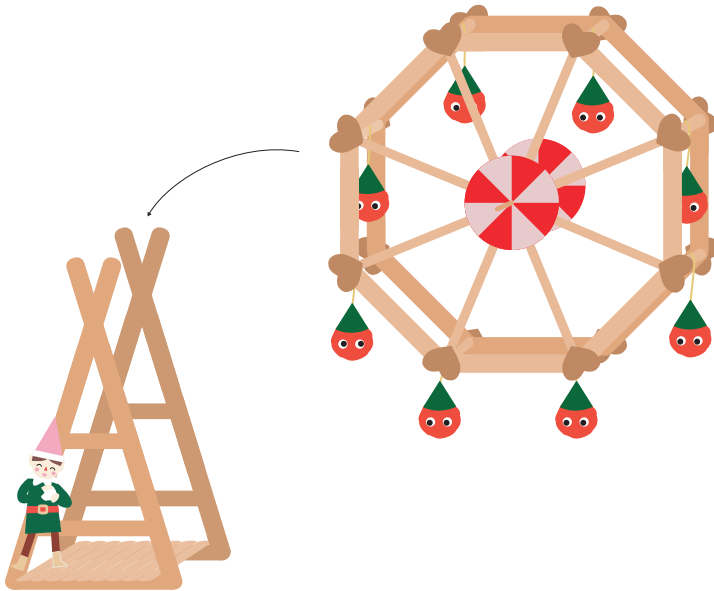

41

