

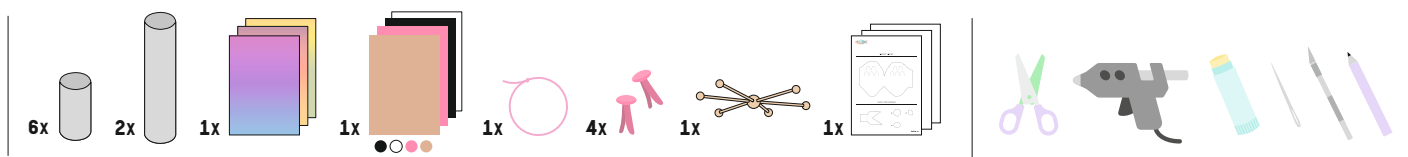

**WHAT YOU NEED**

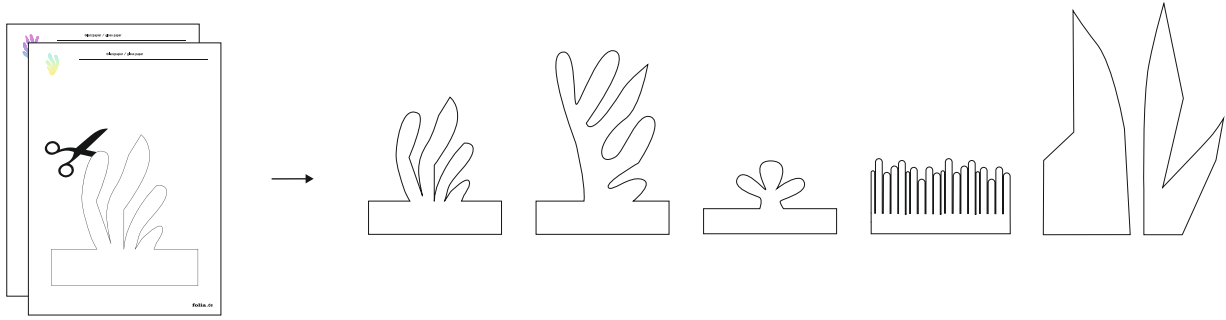

1



2

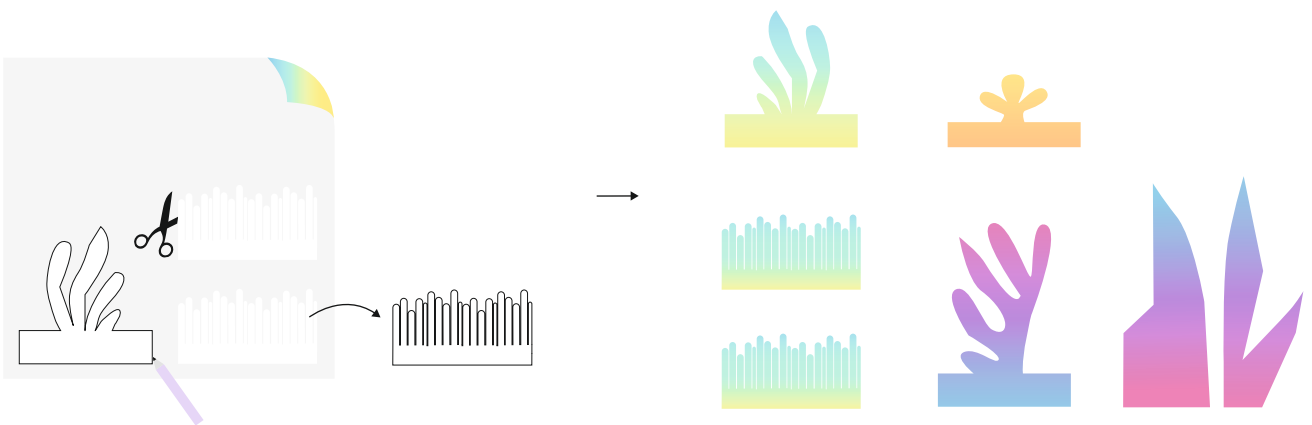

3

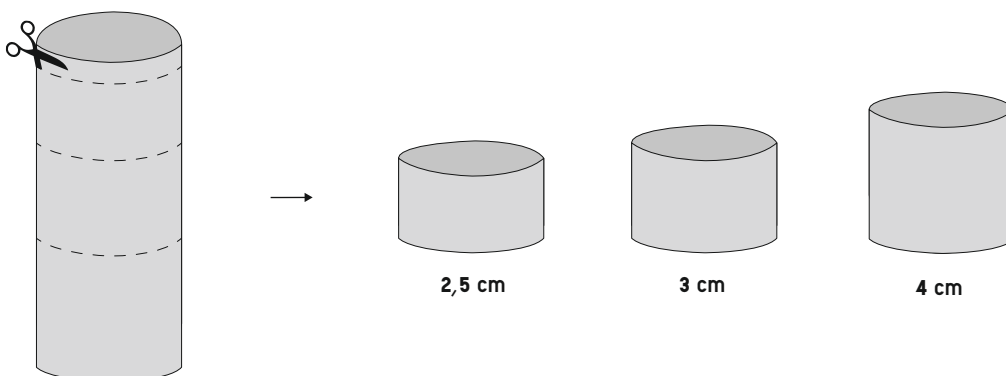

4

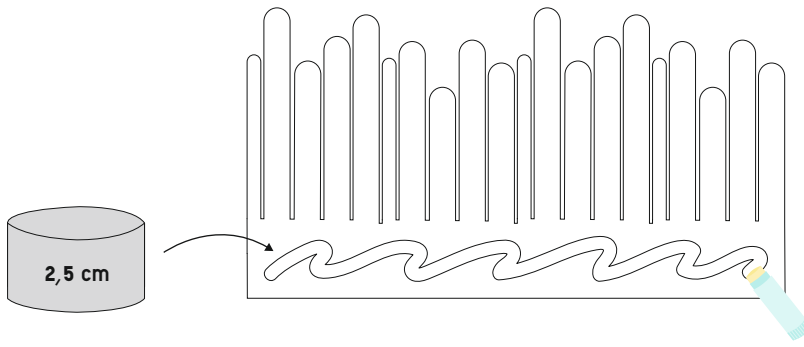

5

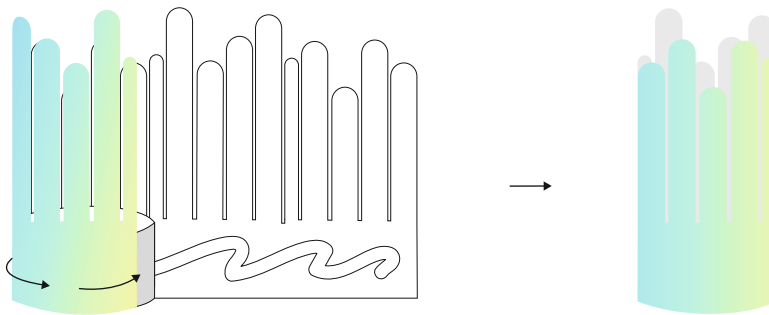

6 Repeat (5-6)

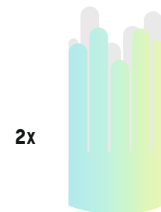
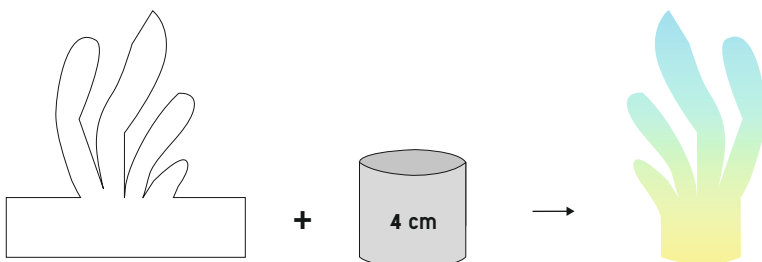
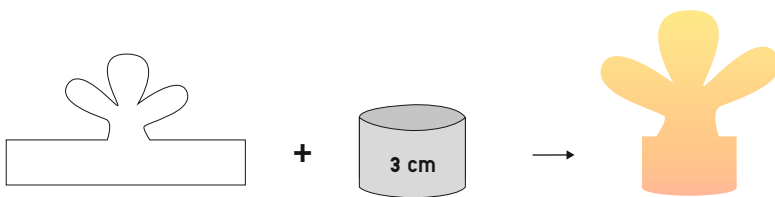

7

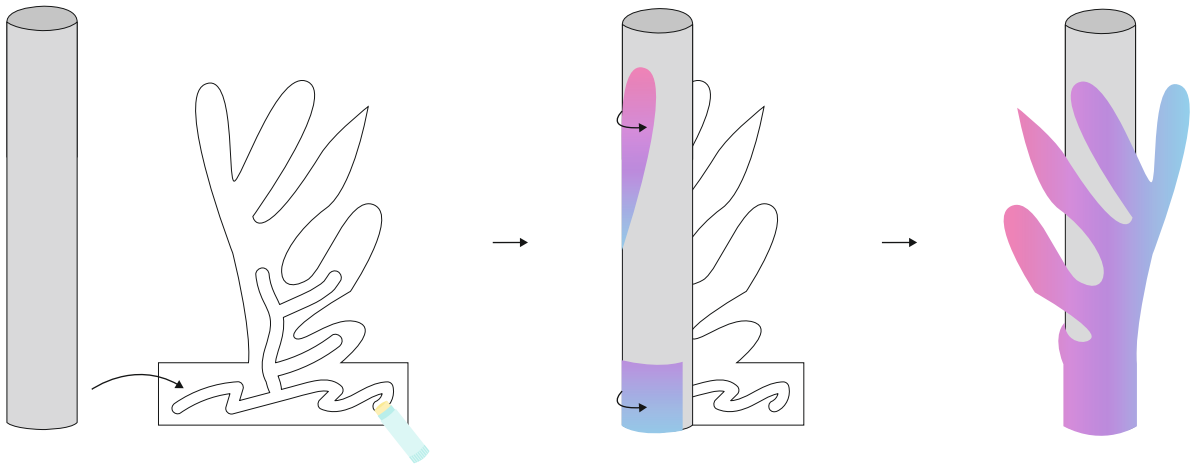

8

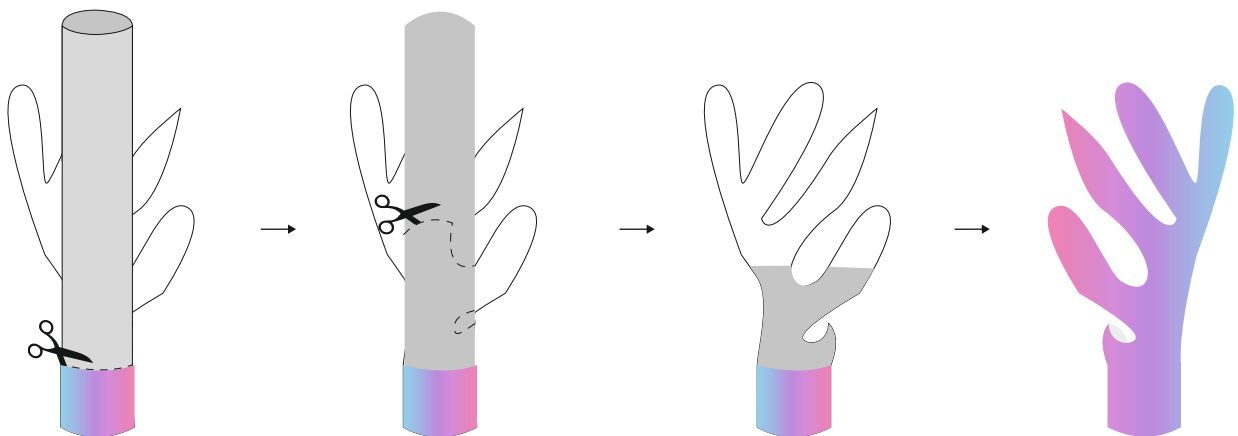

9

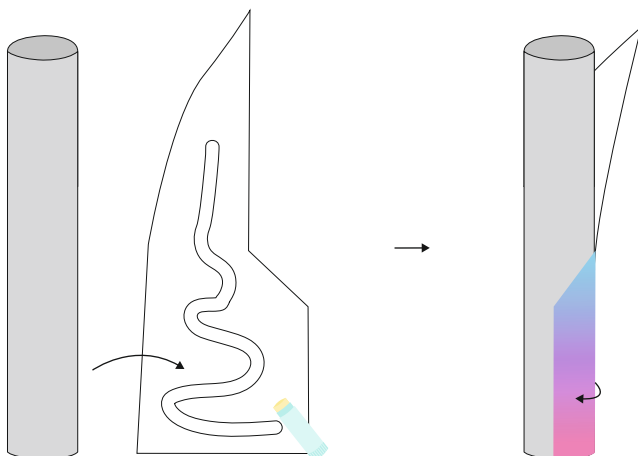

10

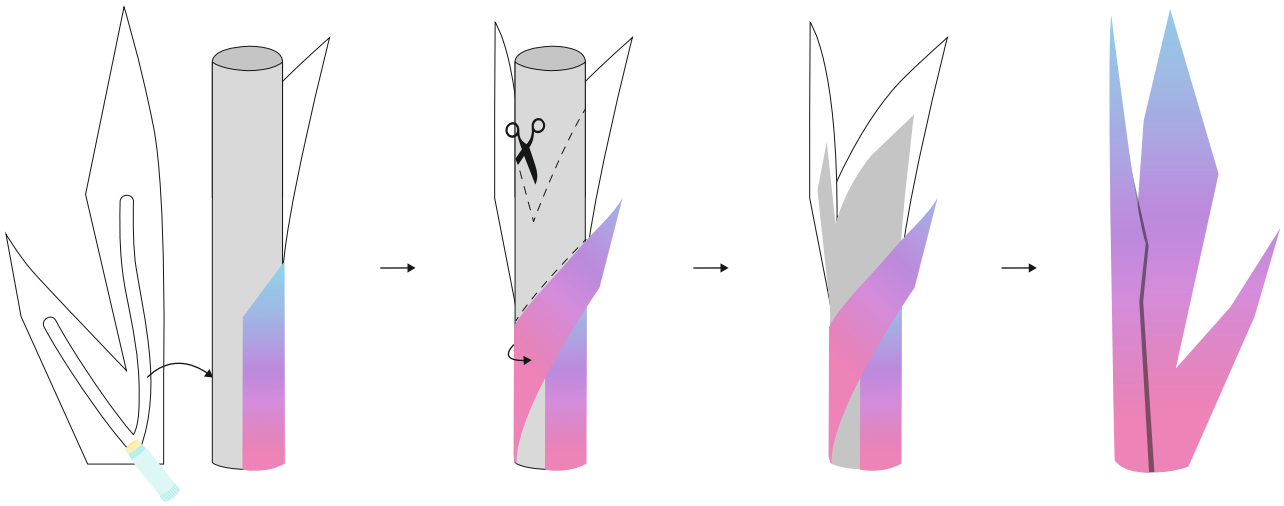

11

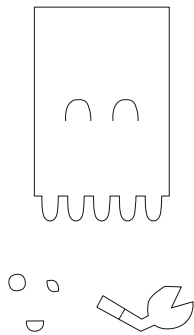
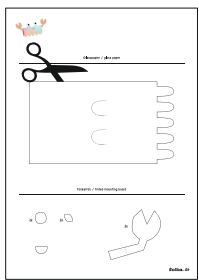

12

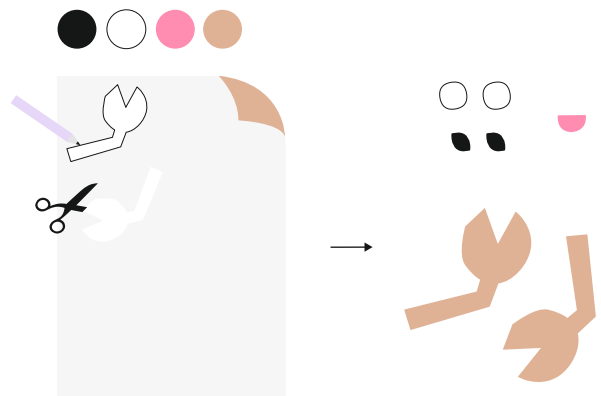

13

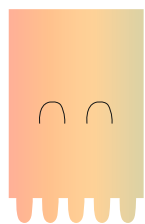
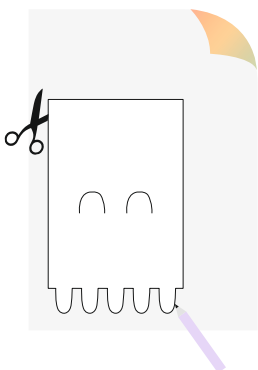

14

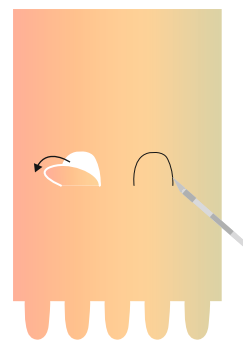

15

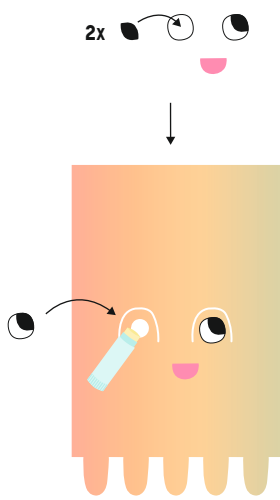

16

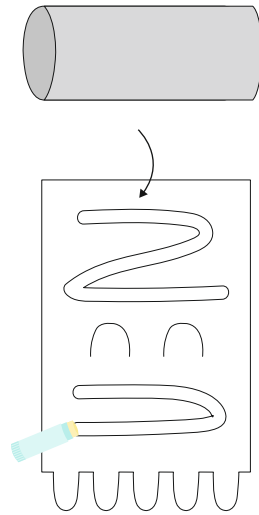

17

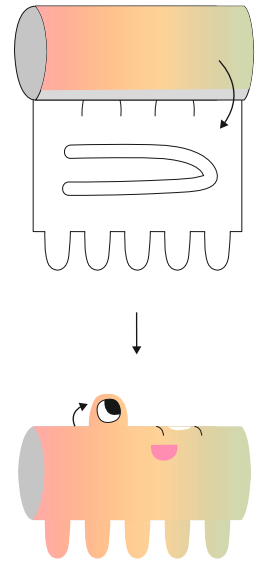

18

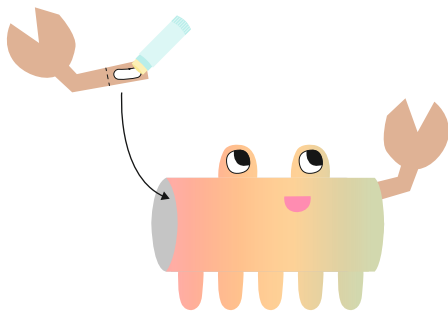

19

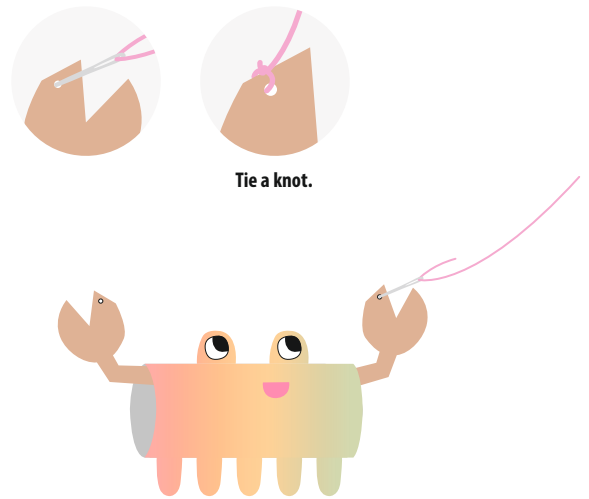

20

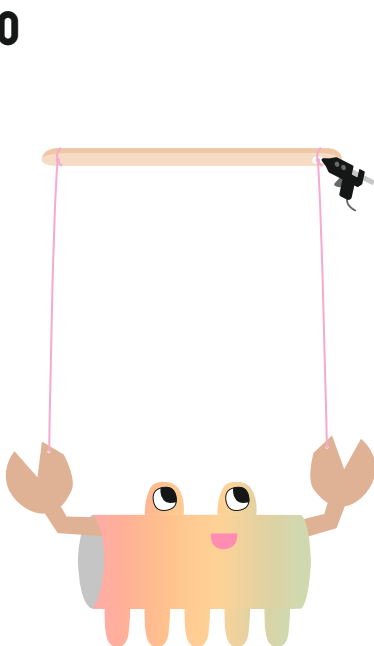

21

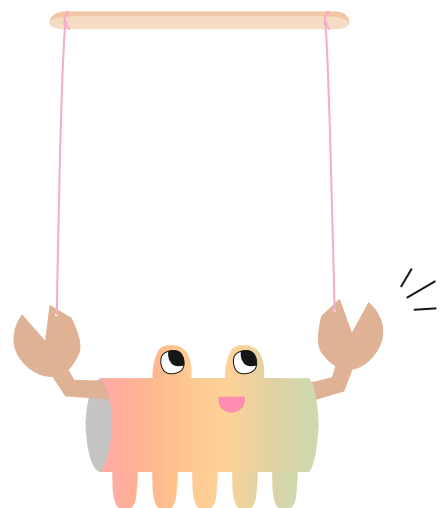

22 

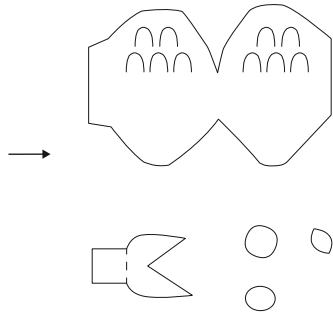
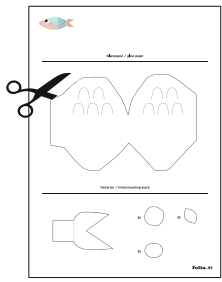

23

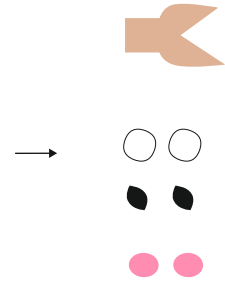
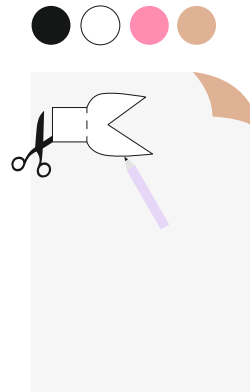

24

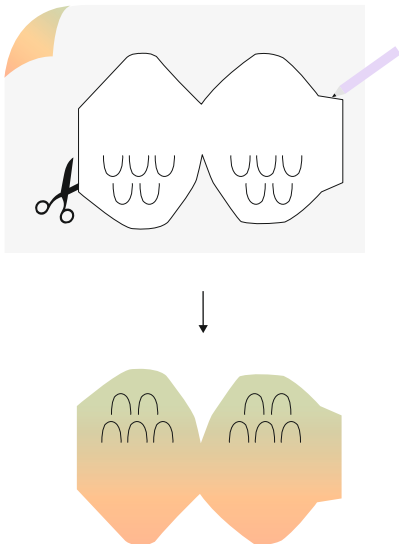

25

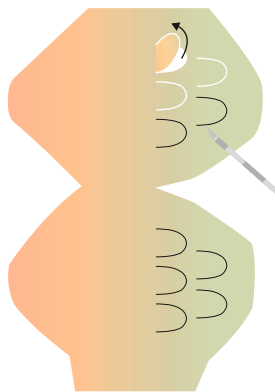

26

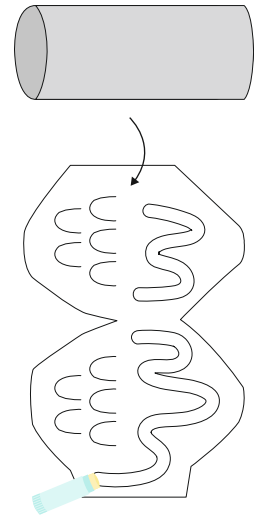

27

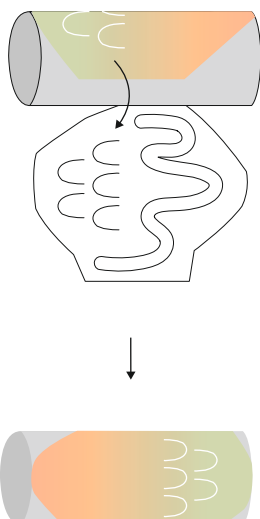

28

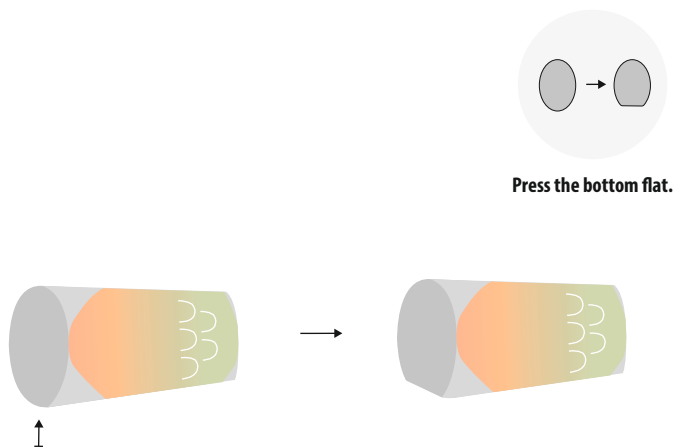

36

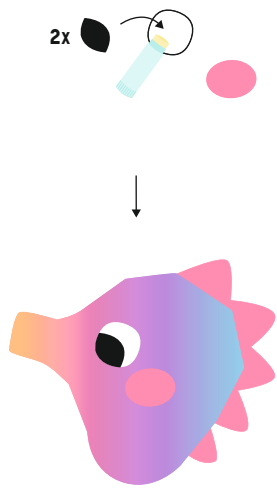

37

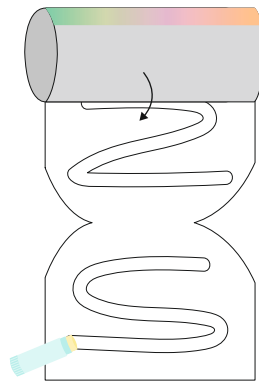

38

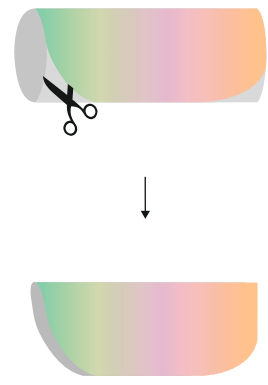

39

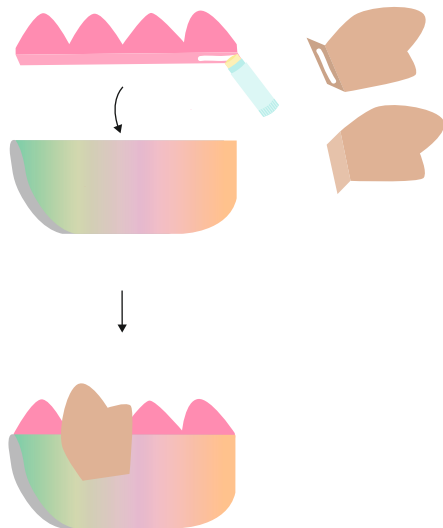

40

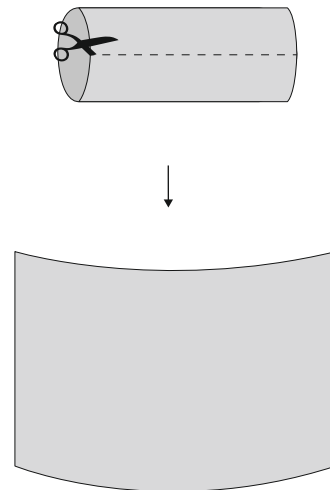

41

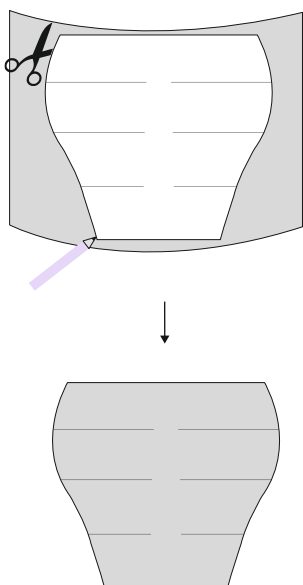

42

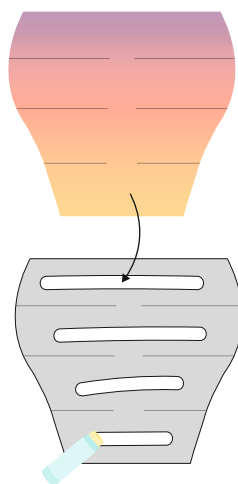

43

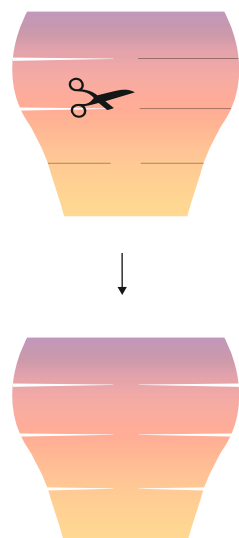

29

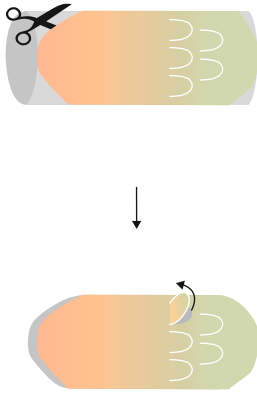

30

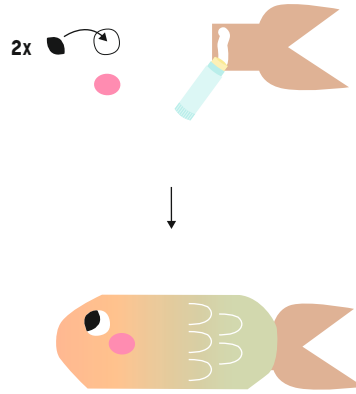

31

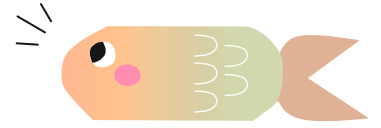

32

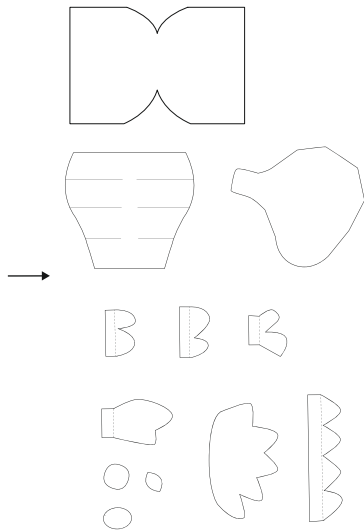
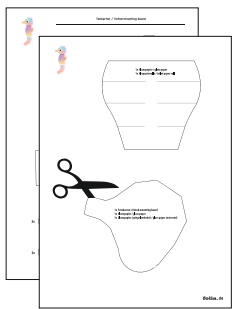

33

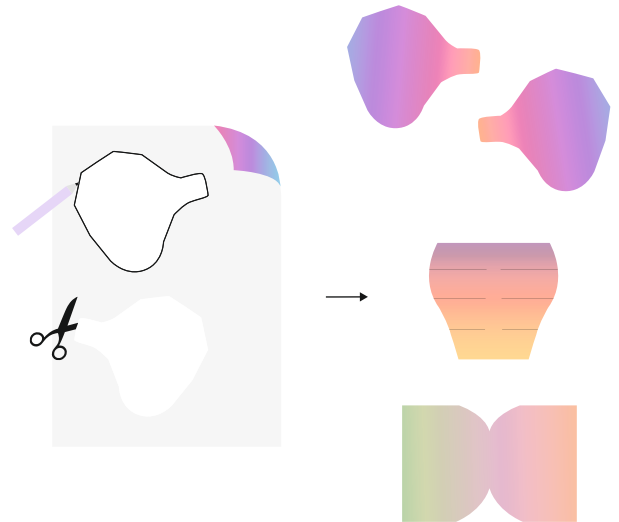

34

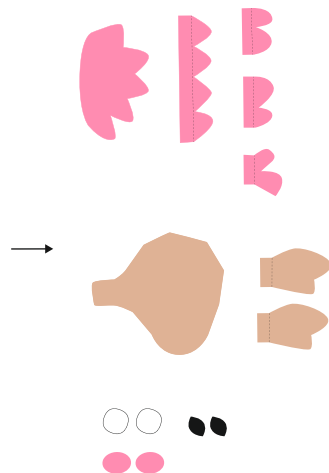
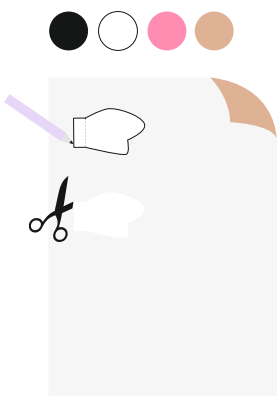

35

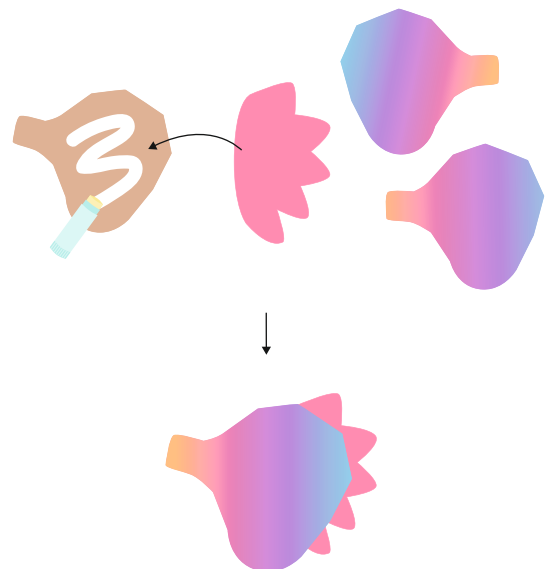

44

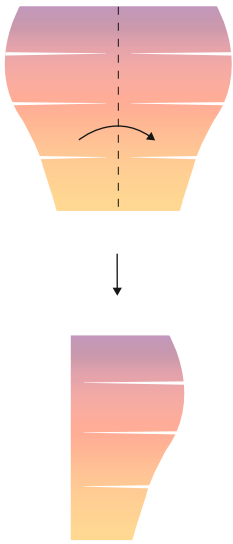

45

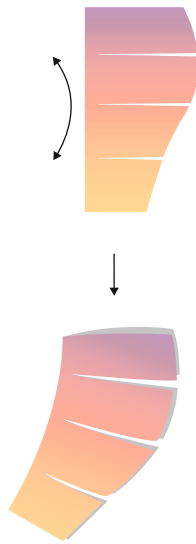

46

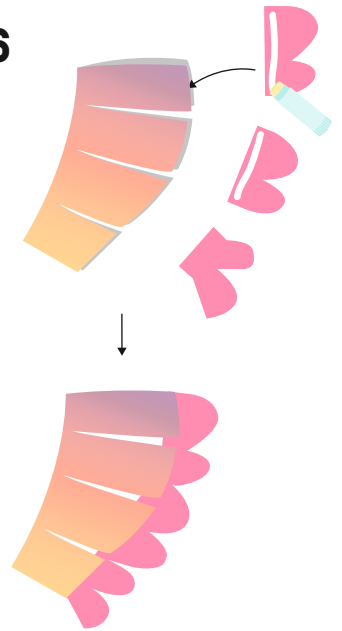

47



48

4x



49

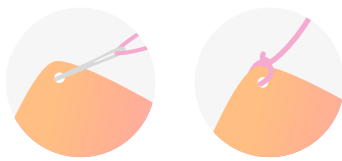

Tie a knot.



50

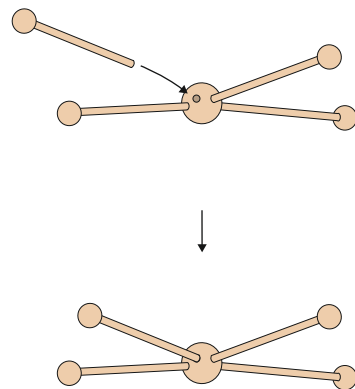

51

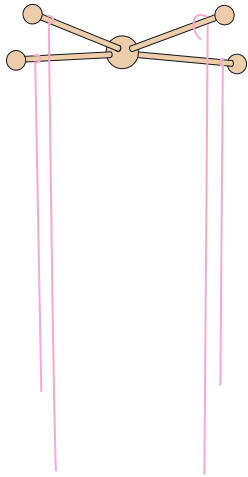

Tie a knot.

52

